



N 沟道增强型场效应晶体管

N-CHANNEL MOSFET

FHP120N08B/FHS120N08B

主要参数 MAIN CHARACTERISTICS

ID	120A
VDSS	80 V
Rdson-typ (@Vgs=10V)	4.8 mΩ
Qg-typ	182nC

用途 APPLICATIONS

逆变电源	Power management for inverter systems
功率开关	Switch mode power supplies
直流电机控制	DC motor control

产品特性 FEATURES

低栅极电荷	Low gate charge
低 Crss (典型值 400pF)	Low Crss (typical 400pF)
开关速度快	Fast switching
100%经过 Rg 测试	100% Rg tested
100%经过雪崩测试	100% avalanche tested
100%经过热阻测试	100% DVDS tested
Trench 工艺	Trench process
RoHS 产品	RoHS product

封装形式 Package

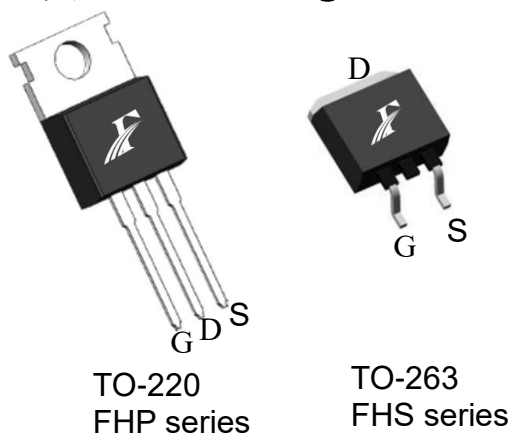

等效电路 Equivalent Circuit

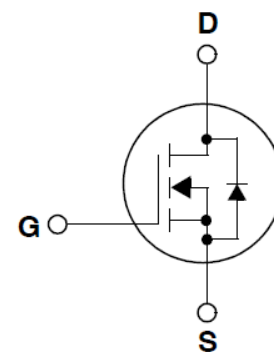

绝对最大额定值 ABSOLUTE RATINGS (Tc=25°C)

项目 Parameter	符号 Symbol	数值 Value		单位 Unit
		FHP120N08B	FHS120N08B	
最高漏极-源极直流电压 Drain-Source Voltage	V _{DS}	80		V
连续漏极电流* Drain Current -continuous *	I _D (T _C =25°C)	120		A
	I _D (T _C =100°C)	87		A
最大脉冲漏极电流 (注 1) Drain Current - pulse (note 1)	I _{DM}	480		A
最高栅源电压 Gate-Source Voltage	V _{GS}	±20		V
单脉冲雪崩能量 (注 2) Single Pulsed Avalanche Energy (note 2)	E _{AS}	264.5		mJ
雪崩电流 (注 1) Avalanche Current (note 1)	I _{AR}	23		A
重复雪崩能量 (注 1) Repetitive Avalanche Current (note 1)	E _{AR}	20		mJ
二极管反向恢复最大电压变化速率 (注 3) Peak Diode Recovery dv/dt (note 3)	dv/dt	5.0		V/ns
耗散功率 Power Dissipation	P _D (T _C =25°C)	245		W
	-Derate above 25°C	1.96		W/°C
最高结温及存储温度 Operating and Storage Temperature Range	T _J , T _{STG}	-55~+150		°C
引线最高焊接温度 Maximum Lead Temperature for Soldering Purposes	T _L	300		°C

*漏极电流由最高结温限制

*Drain current limited by maximum junction temperature

电特性 ELECTRICAL CHARACTERISTICS

项目 Parameter	符号 Symbol	测试条件 Tests conditions	最小 Min	典型 Typ	最大 Max	单位 Units
关态特性 Off –Characteristics						
漏-源击穿电压 Drain-Source Voltage	BV _{DSS}	I _D =250μA, V _{GS} =0V	80	-	-	V
击穿电压温度特性 Breakdown Voltage Temperature Coefficient	ΔBV _{DSS} /ΔT _J	I _D =250μA, referenced to 25°C	-	0.08	-	V/°C
零栅压下漏极漏电流 Zero Gate Voltage Drain Current	I _{DSS}	V _{DS} =80V, V _{GS} =0V, T _C =25°C	-	-	1	μA
		V _{DS} =64V, T _C =125°C	-	-	50	μA
栅极体漏电流 Gate-body leakage current	I _{GSS} (F/R)	V _{DS} =0V, V _{GS} =±20V	-	-	±100	nA
通态特性 On-Characteristics						
阈值电压 Gate Threshold Voltage	V _{GS(th)}	V _{DS} = V _{GS} , I _D =250μA	2.0	-	4.0	V
静态导通电阻 Static Drain-Source On-Resistance	R _{DS(ON)}	V _{GS} =10V , I _D =50A	-	4.8	5.9	mΩ
正向跨导 Forward Transconductance	g _{fs}	V _{DS} = 10V, I _D =50A (note 4)	-	68	-	S
动态特性 Dynamic Characteristics						
栅电阻 Gate Resistance	R _g	f=1.0MHz, V _{DS} OPEN	-	2.5	-	Ω
输入电容 Input capacitance	C _{iss}	V _{DS} =40V, V _{GS} =0V, f=1.0MHz	-	8970	-	pF
输出电容 Output capacitance	C _{oss}		-	625	-	
反向传输电容 Reverse transfer capacitance	C _{rss}		-	400	-	
开关特性 Switching Characteristics						
延迟时间 Turn-On delay time	t _{d(on)}	V _{DD} =40V, I _D =30A, R _G =4.7Ω V _{GS} =10V (note 4, 5)	-	35	-	ns
上升时间 Turn-On rise time	t _r		-	75	-	ns
延迟时间 Turn-Off delay time	t _{d(off)}		-	171	-	ns
下降时间 Turn-Off Fall time	t _f		-	68	-	ns
栅极电荷总量 Total Gate Charge	Q _g	V _{DS} =64V , I _D =30A , V _{GS} =10V (note 4, 5)	-	182	-	nC
栅-源电荷 Gate-Source charge	Q _{gs}		-	40	-	nC
栅-漏电荷 Gate-Drain charge	Q _{gd}		-	105	-	nC
漏-源二极管特性及最大额定值 Drain-Source Diode Characteristics and Maximum Ratings						
正向最大连续电流 Maximum Continuous Drain -Source Diode Forward Current		I _S	-	-	120	A
正向最大脉冲电流 Maximum Pulsed Drain-Source Diode Forward Current		I _{SM}	-	-	480	A
正向压降 Drain-Source Diode Forward Voltage	V _{SD}	V _{GS} =0V, I _S =50A	-	-	1.4	V
反向恢复时间 Reverse recovery time	t _{rr}	V _{GS} =0V, I _S =50A, dI _F /dt=100A/μs (note 4)	-	49	-	ns
反向恢复电荷 Reverse recovery charge	Q _{rr}		-	90	-	nC

热特性 THERMAL CHARACTERISTIC

项目 Parameter	符号 Symbol	最大值 Max	单位 Unit
结到管壳的热阻 Thermal Resistance, Junction to Case	Rth(j-c)	0.51	°C/W
结到环境的热阻 Thermal Resistance, Junction to Ambient	Rth(j-A)	62.5	°C/W

注释:

- 1: 脉冲宽度由最高结温限制
- 2: L=1mH, IAS=23A, VDD=50V, RG=25 Ω, 起始结温 TJ=25°C
- 3: ISD ≤120A, di/dt ≤300A/μs, VDD≤BV_{DSS}, 起始结温 TJ=25°C
- 4: 脉冲测试: 脉冲宽度 ≤300μs, 占空比≤2%
- 5: 基本与工作温度无关

Notes:

- 1: Pulse width limited by maximum junction temperature
- 2: L=1mH, IAS=23A, VDD=50V, RG=25 Ω, Starting TJ=25°C
- 3: ISD ≤120A, di/dt ≤300A/μs, VDD≤BV_{DSS}, Starting TJ=25°C
- 4: Pulse Test: Pulse Width ≤300μs, Duty Cycle≤2%
- 5: Essentially independent of operating temperature

Typical Performance Characteristics

Fig. 1. On-state characteristics

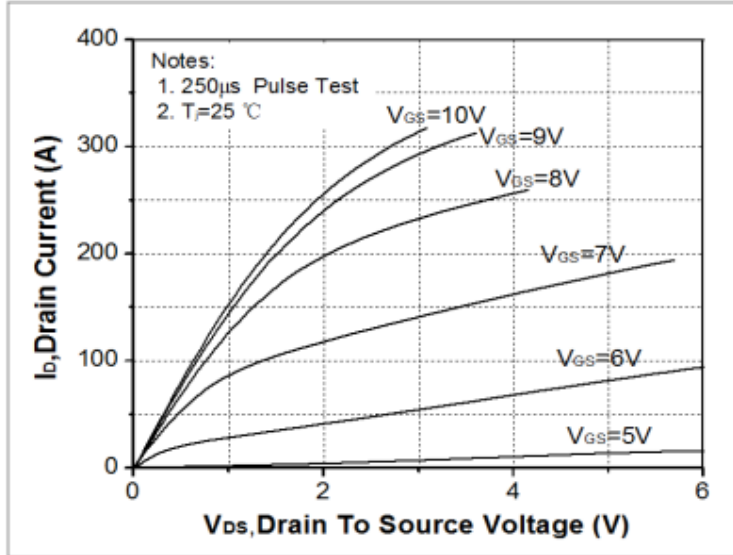

Fig. 2. Transfer Characteristics

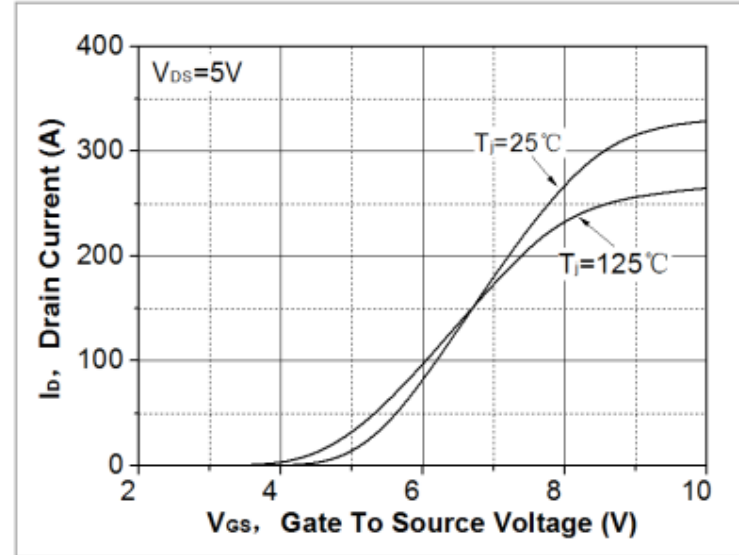

Fig. 3. On-resistance variation vs. drain current and gate voltage

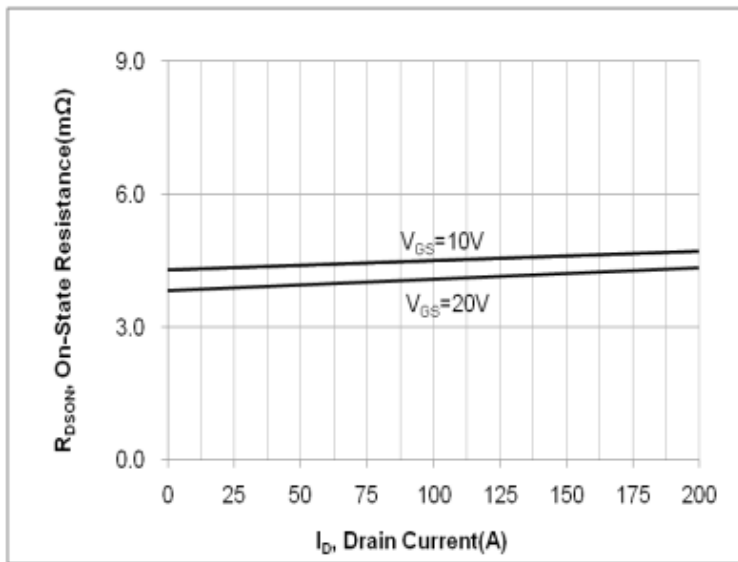

Fig. 4. On-state current vs. diode forward voltage

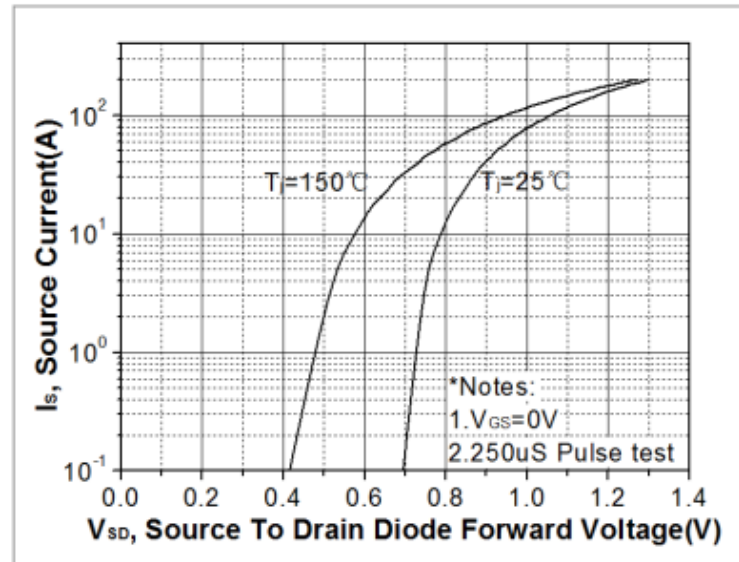

Fig 5. Breakdown voltage variation vs. junction temperature

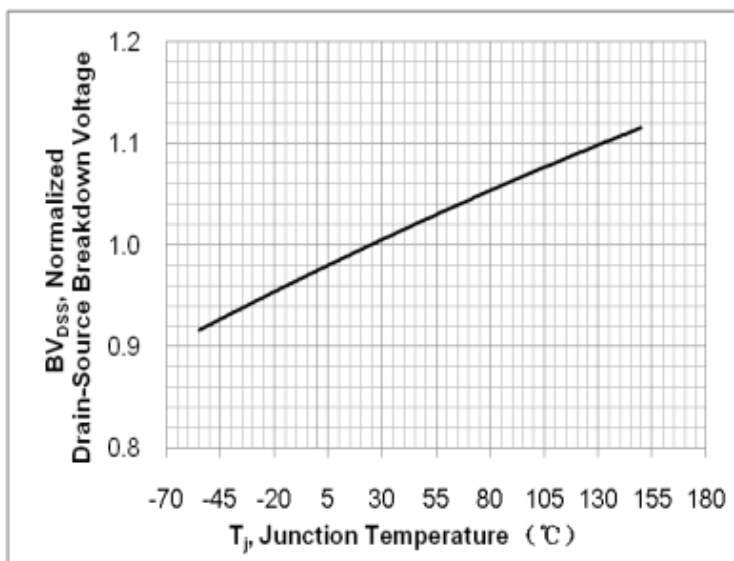

Fig. 6. On-resistance variation vs. junction temperature

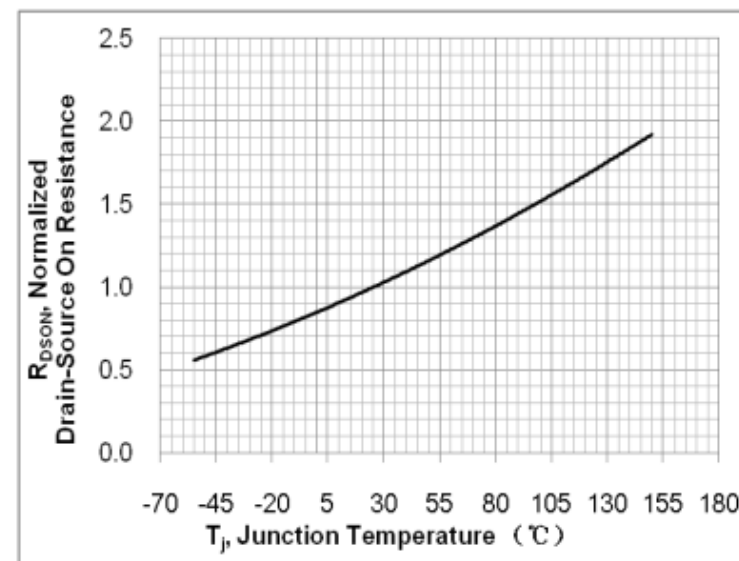

Fig. 7. Gate charge characteristics

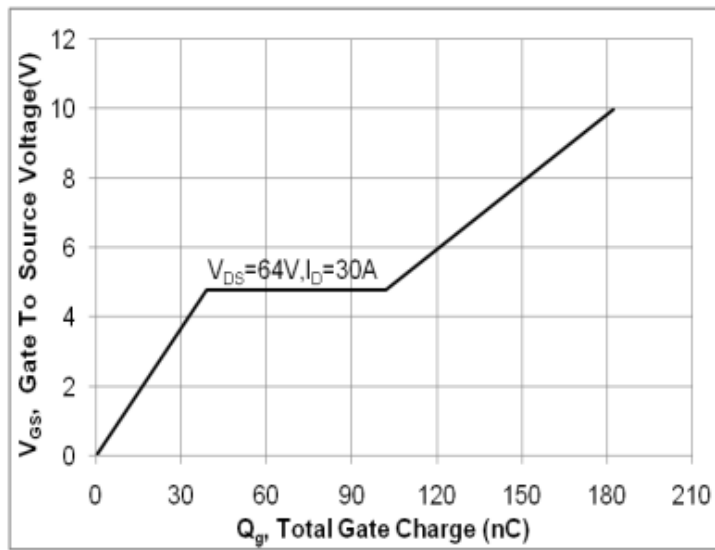

Fig. 8. Capacitance Characteristics

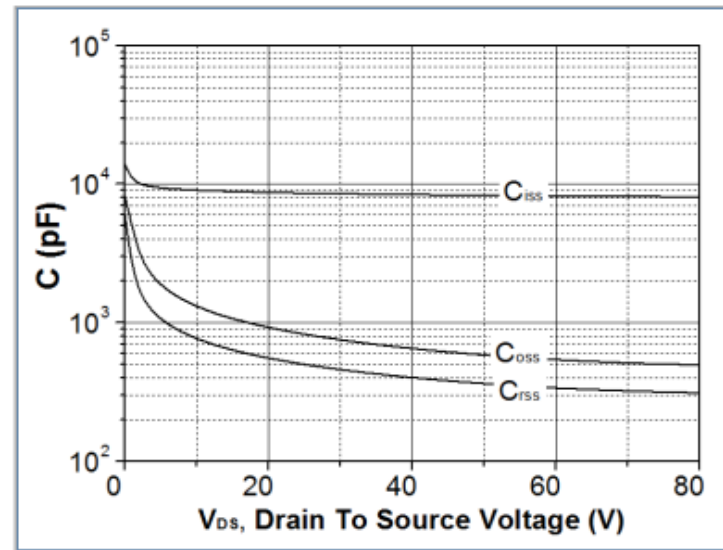

Fig. 9. Maximum safe operating area (TO-220 & TO-263)

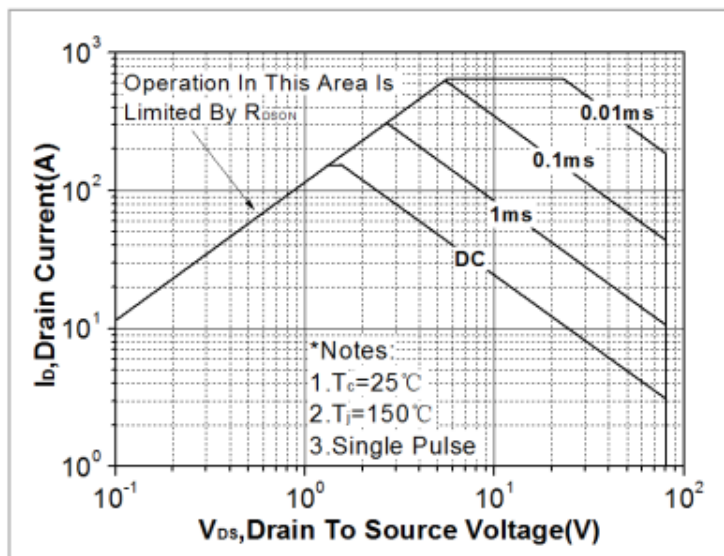

Fig. 10. Maximum drain current vs. case temperature

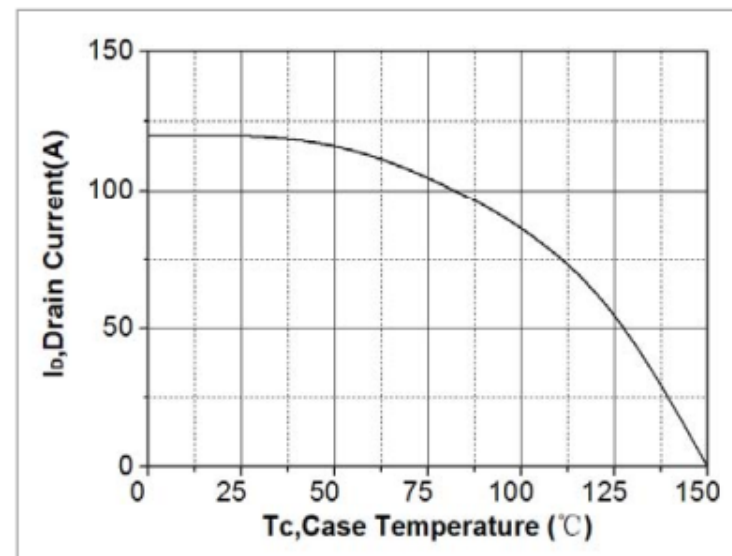
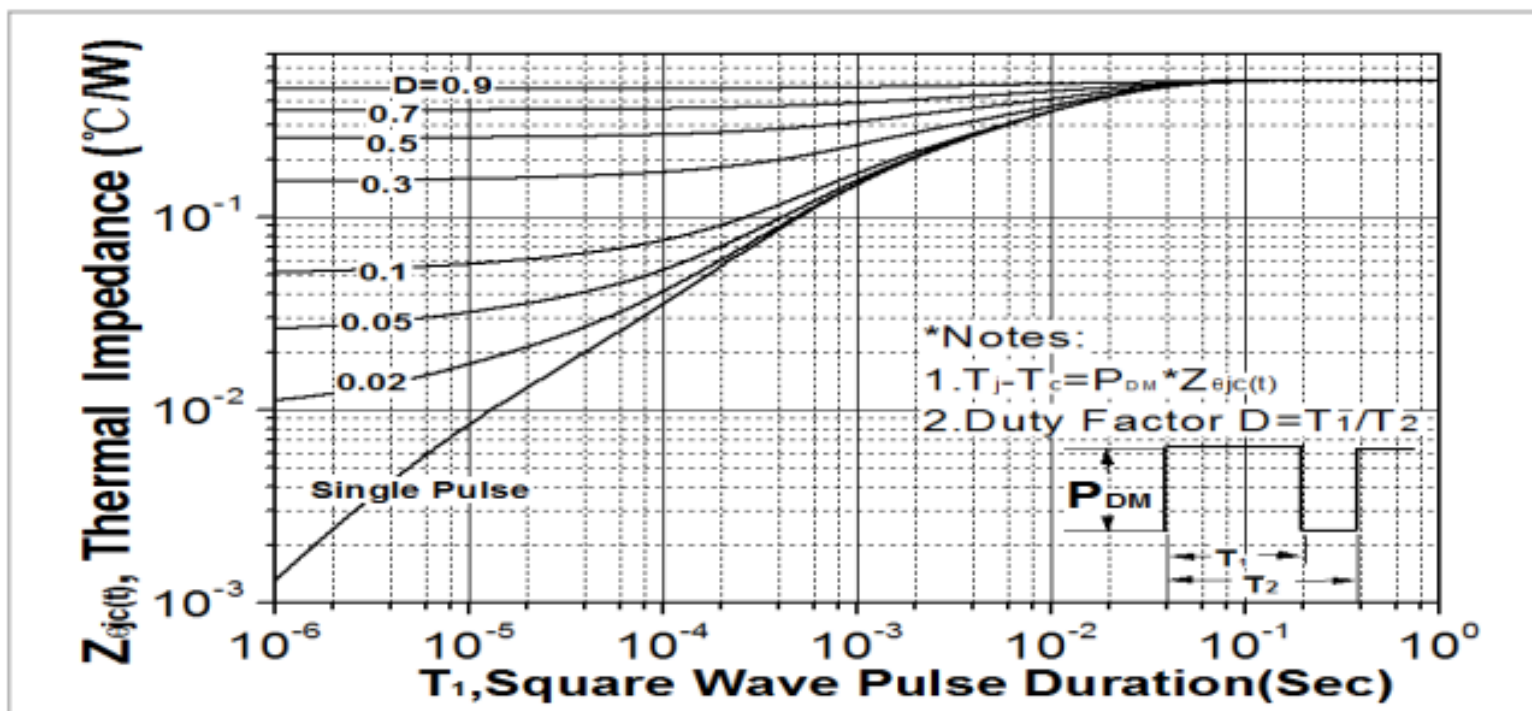

Fig. 11. Transient thermal response curve (TO-220 & TO-263)



Test Circuit & Waveform

Fig. 12. Gate charge test circuit & waveform

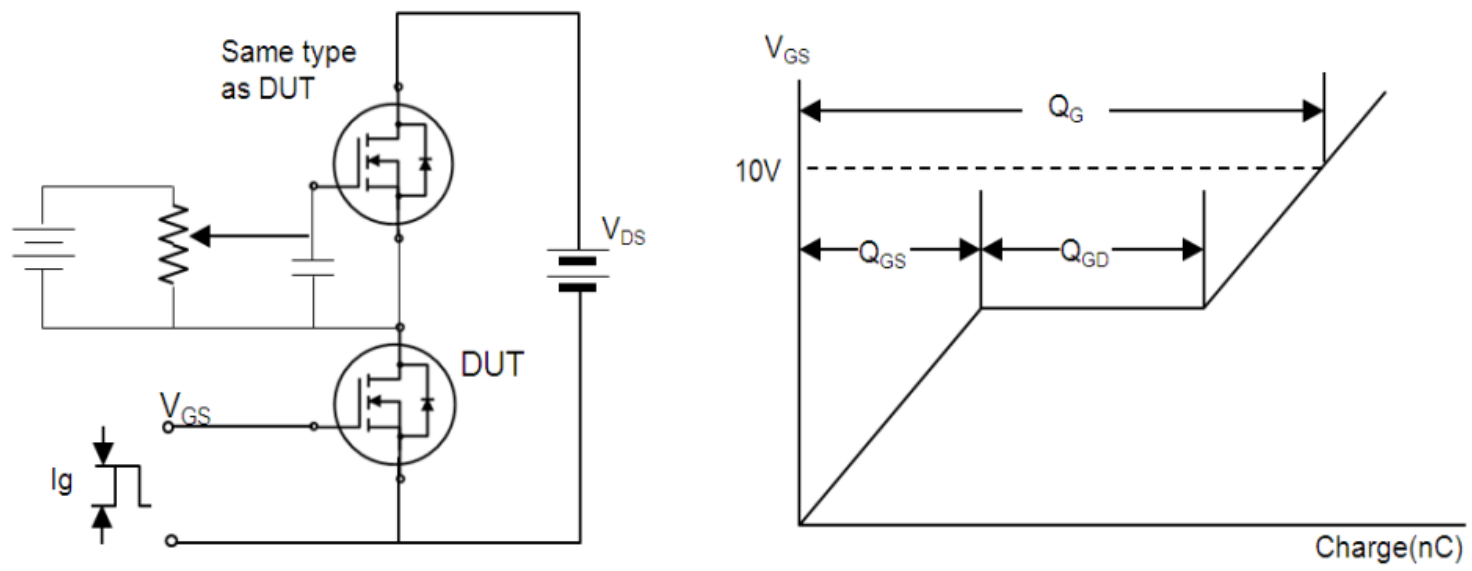

Fig. 13. Switching time test circuit & waveform

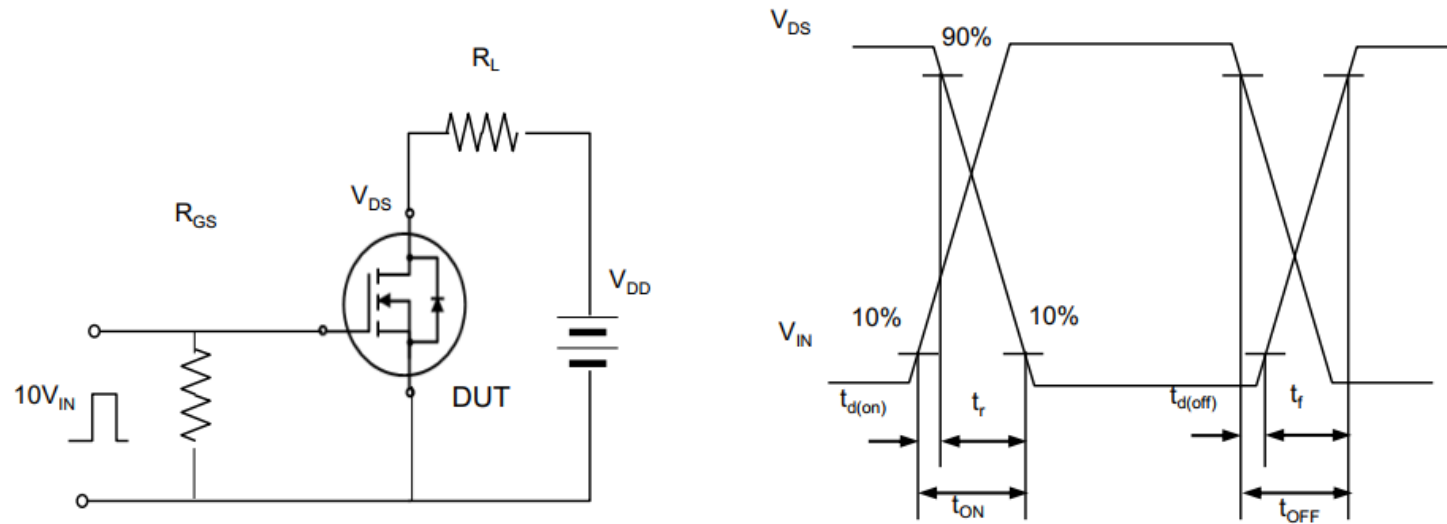

Fig. 14. Unclamped Inductive switching test circuit & waveform

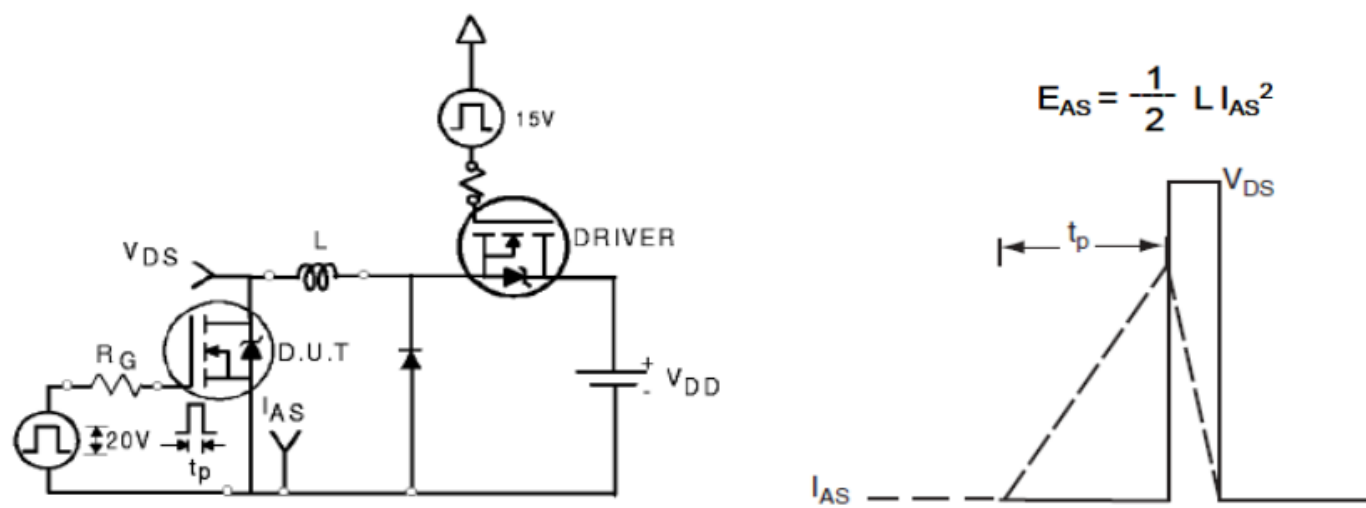
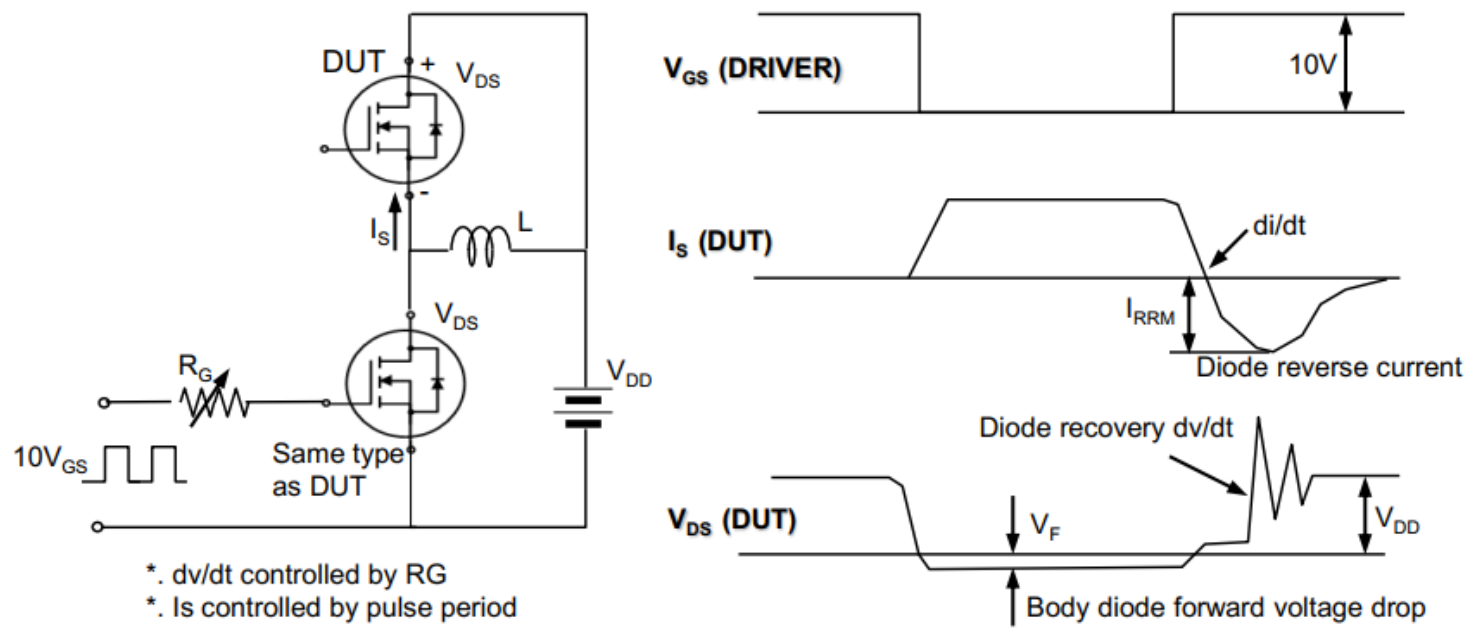
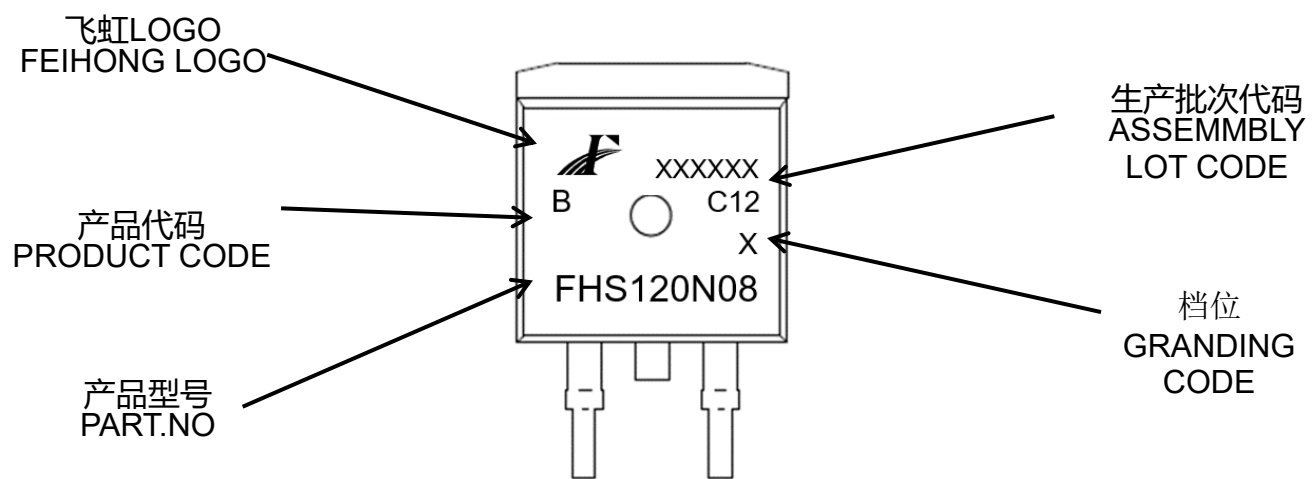
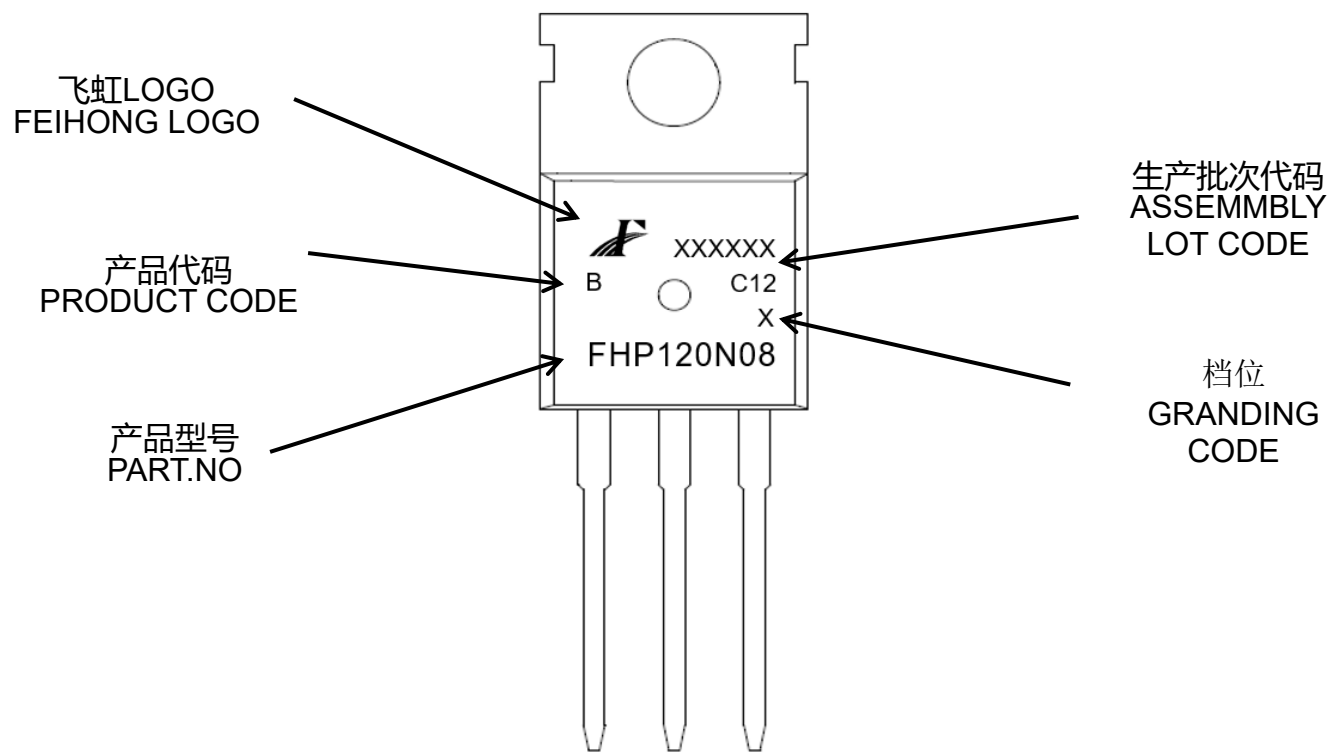

Fig. 15. Peak diode recovery dv/dt test circuit & waveform



印记 Marking:



外形尺寸:

Package Dimension:

TO-220

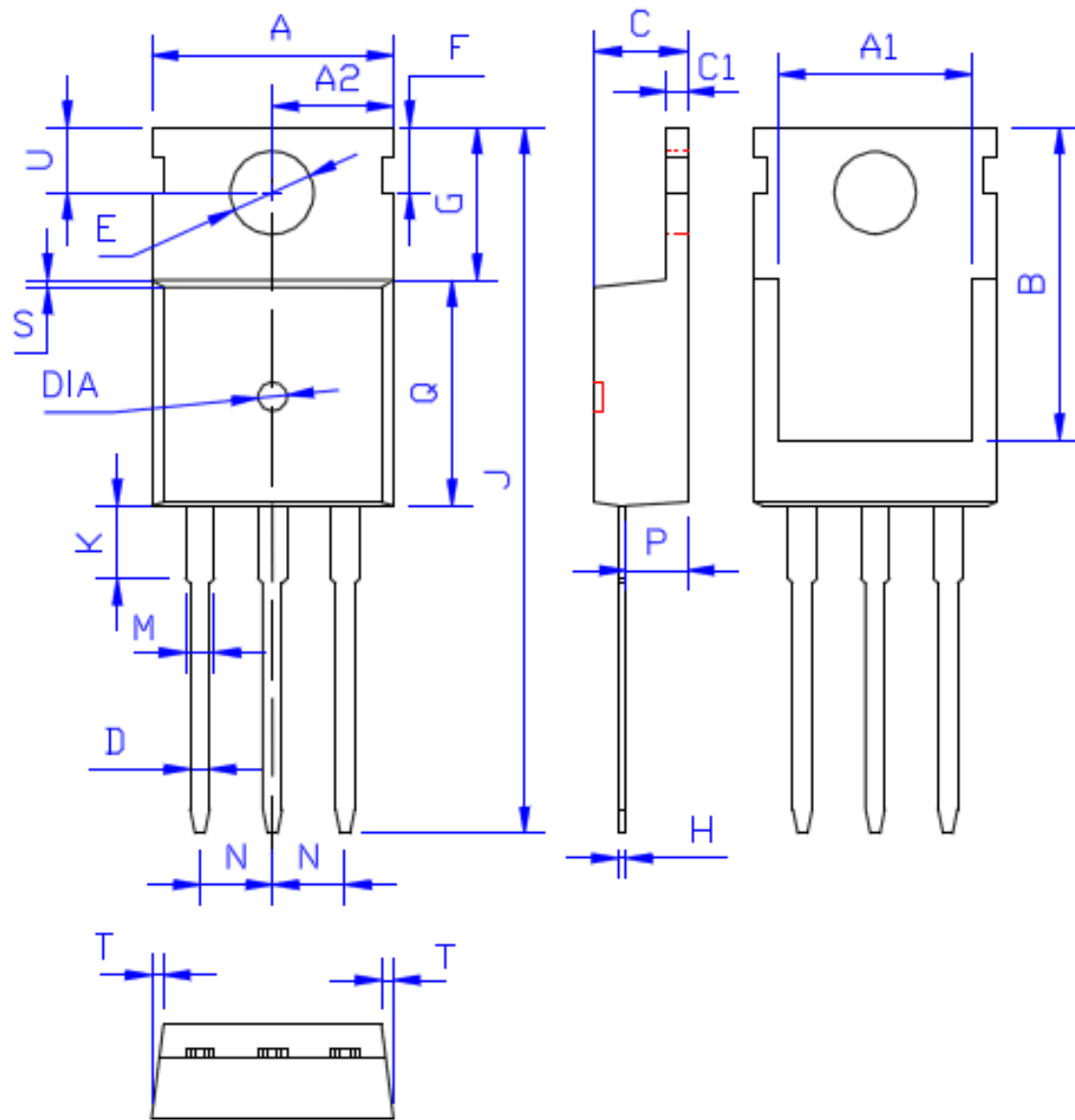

DIM	MILLIMETERS
A	10.00 ± 0.30
A1	8.00 ± 0.30
A2	5.00 ± 0.30
B	13.20 ± 0.40
C	4.50 ± 0.20
C1	1.30 ± 0.20
D	0.80 ± 0.20
E	3.60 ± 0.20
F	3.00 ± 0.30
G	6.60 ± 0.40
H	0.50 ± 0.20
J	28.88 ± 0.50
K	3.00 ± 0.30
M	1.30 ± 0.30
N	Typical 2.54
P	2.40 ± 0.40
Q	9.20 ± 0.40
S	0.25 ± 0.15
T	0.25 ± 0.15
U	2.80 ± 0.30
DIA	宽 1.50 ± 0.10 深 0.50 MAX

(Unit: mm)

外形尺寸:

Package Dimension:

TO-263

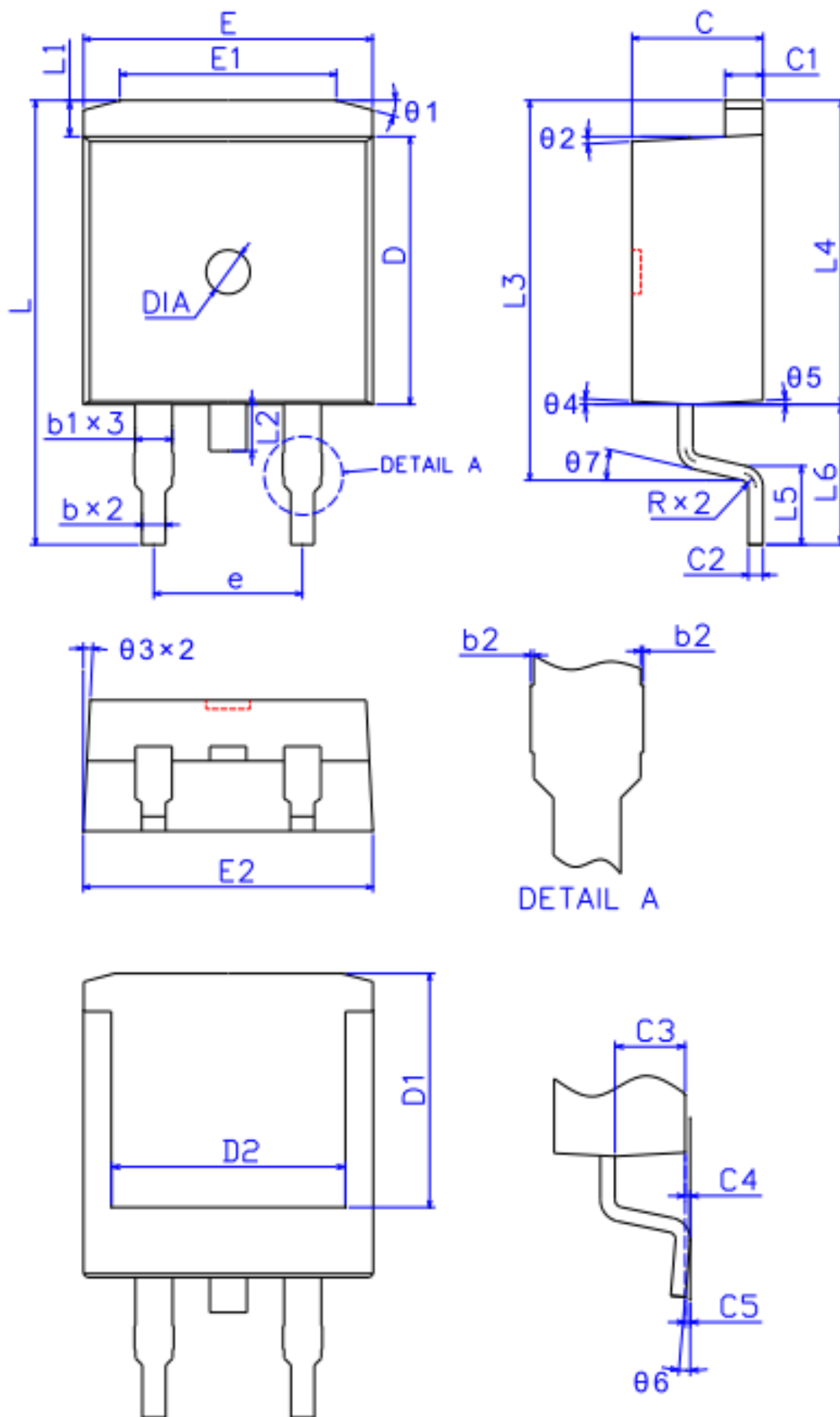

标注	尺寸(mm)
E	9.88 ± 0.10
E1	7.40 ± 0.20
E2	9.90 ± 0.15
L	15.20 ± 0.25
L1	1.30 ± 0.15
L2	1.60 ± 0.10
L3	13.00 ± 0.20
L4	10.40 ± 0.15
L5	2.60 ± 0.15
L6	4.80 ± 0.20
b	0.80 ± 0.07
b1	1.27 ± 0.07
b2	0.05 ± 0.07
C	4.48 ± 0.10
C1	1.30 ± 0.07
C2	0.50 ± 0.07
C3	2.40 ± 0.06
C4	0.10 ± 0.08
C5	0.10 ± 0.08
D	9.20 ± 0.10
D1	8.00 ± 0.10
D2	8.00 ± 0.10
R	0.50 ± 0.10
θ_1	$15^\circ \pm 2^\circ$
θ_2	$3^\circ \pm 2^\circ$
θ_3	$3^\circ \pm 2^\circ$
θ_4	$3^\circ \pm 2^\circ$
θ_5	$3^\circ \pm 2^\circ$
θ_6	$0^\circ \sim 6^\circ$
θ_7	$13^\circ \pm 2^\circ$
e	5.08 ± 0.10
DIA	宽 1.50 ± 0.10 深 0.30 ± 0.15